



# 2216Vw User Manual

## 1. Preface

### About This Guide

This guide describes the monitor's features, setup, and operation. **Information in this document is subject to change without notice.**

The sections are as follows:

- [Safety Instructions](#): lists safety information.
- [Setup](#): describes the initial setup process.
- [Using the Monitor](#): gives an overview of how to use the monitor.
- [Drivers](#): provides driver installation instructions for Windows.
- [Technical Support](#): provides tips and solutions for common problems.
- [Product Information](#): lists the technical specifications of the monitor.
- [Warranty Statement](#): Warranty Statement used in Europe.

### National Conventions

The following subsections describe notational conventions used in this document.

### Notes, Cautions, and Warnings

Throughout this guide, blocks of text may be accompanied by an icon and printed in bold type or in italic type. These blocks are notes, cautions, and warnings, and they are used as follows:



**NOTE: A NOTE indicates important information that helps you make better use of your computer system.**



**CAUTION: A CAUTION indicates either potential damage to hardware or loss of data and tells you how to avoid the problem.**



**WARNING: A WARNING indicates the potential for bodily harm and tells you how to avoid the problem.**

Some warnings may appear in alternate formats and may be unaccompanied by an icon. In such cases, the specific presentation of the warning is mandated by regulatory authority.

### Product Registration

Please link [www.aoc.com](http://www.aoc.com), select your country or region, log in Product Registration to register

## 2. Safety Introduction

### FCC Notice

#### FCC Class B Radio Frequency Interference Statement WARNING: (FOR FCC CERTIFIED MODELS)

**NOTE:** This equipment has been tested and found to comply with the limits for a Class B digital device, pursuant to Part 15 of the FCC Rules. These limits are designed to provide reasonable protection against harmful interference in a residential installation. This equipment generates, uses and can radiate radio frequency energy, and if not installed and used in accordance with the instructions, may cause harmful interference to radio communications. However, there is no guarantee that interference will not occur in a particular installation. If this equipment does cause harmful interference to radio or television reception, which can be determined by turning the equipment off and on, the user is encouraged to try to correct the interference by one or more of the following measures:

1. Reorient or relocate the receiving antenna.
2. Increase the separation between the equipment and receiver.
3. Connect the equipment into an outlet on a circuit different from that to which the receiver is connected.
4. Consult the dealer or an experienced radio/TV technician for help.

#### NOTICE :

1. The changes or modifications not expressly approved by the party responsible for compliance could void the user's authority to operate the equipment.
2. Shielded interface cables and AC power cord, if any, must be used in order to comply with the emission limits.
3. The manufacturer is not responsible for any radio or TV interference caused by unauthorized modification to this equipment. It is the responsibilities of the user to correct such interference.

### WEEE Declaration

Disposal of Waste Equipment by Users in Private Household in the European Union.



This symbol on the product or on its packaging indicates that this product must not be disposed of with your other household waste. Instead, it is your responsibility to dispose of your waste equipment by handing it over to a designated collection point for the recycling of waste electrical and electronic equipment. The separate collection and recycling of your waste equipment at the time of disposal will help to conserve natural resources and ensure that it is recycled in a manner that protects human health and the environment. For more information about where you can drop off your waste equipment for recycling, please contact your local city office, your household waste disposal service or the shop where you purchased the product .

### HG Declaration

 SAFETY: Lamp Disposal

LAMP(S) INSIDE THIS PRODUCT CONTAIN MERCURY AND MUST BE RECYCLED OR DISPOSED OF ACCORDING TO LOCAL, STATE OR FEDERAL LAWS. FOR MORE INFORMATION, CONTACT THE ELECTRONIC INDUSTRIES ALLIANCE AT [WWW.EIAE.ORG](http://WWW.EIAE.ORG).

## Precautions



WARNING: Use of controls, adjustments, or procedures other than those specified in this documentation may result in exposure to shock, electrical hazards, and/or mechanical hazards.

Read and follow these precautions when connecting and using your computer monitor:

### PRECAUTIONS

- Do not use the monitor near water, e.g. near a bathtub, washbowl, kitchen sink, laundry tub, swimming pool or in a wet basement.
- Do not place the monitor on an unstable cart, stand, or table. If the monitor falls, it can injure a person and cause serious damage to the appliance. Use only a cart or stand recommended by the manufacturer or sold with the monitor. If you mount the monitor on a wall or shelf, use a mounting kit approved by the manufacturer and follow the kit instructions.
- Slots and openings in the back and bottom of the cabinet are provided for ventilation. To ensure reliable operation of the monitor and to protect it from overheating, be sure these openings are not blocked or covered. Do not place the monitor on a bed, sofa, rug, or similar surface. Do not place the monitor near or over a radiator or heat register. Do not place the monitor in a bookcase or cabinet unless proper ventilation is provided.
- The monitor should be operated only from the type of power source indicated on the label. If you are not sure of the type of power supplied to your home, consult your dealer or local power company.
- The monitor is equipped with a three-pronged grounded plug, a plug with a third (grounding) pin. This plug will fit only into a grounded power outlet as a safety feature. If your outlet does not accommodate the three-wire plug, have an electrician install the correct outlet, or use an adapter to ground the appliance safely. Do not defeat the safety purpose of the grounded plug.
- Unplug the unit during a lightning storm or when it will not be used for long periods of time. This will protect the monitor from damage due to power surges.
- Do not overload power strips and extension cords. Overloading can result in fire or electric shock.
- Never push any object into the slot on the monitor cabinet. It could short circuit parts causing a fire or electric shock. Never spill liquids on the monitor.
- Do not attempt to service the monitor yourself; opening or removing covers can expose you to dangerous voltages and other hazards. Please refer all servicing to qualified service personnel.
- To ensure satisfactory operation, use the monitor only with UL listed computers which have appropriate configured receptacles marked between 100 - 240V AC, Min. 5A.
- The wall socket shall be installed near the equipment and shall be easily accessible.
- For use only with the attached power adapter (Output 12Vdc) which have **UL,CSA** listed license(Only for monitors with power adapter).
- Please make sure to clean the cabinet regularly with the provided cloth , you can use soft-cleanser to clean the stain , instead of severe spray cleanser which will cauterize the monitor cabinet.
- Dont leak liquid into monitor which will result in the damage of chassis or component. Please unplug before cleaning ,and do not scratch the screen with hard things.

## 3. Setup

### Setup the stand and base

Please setup or remove the base following below steps.

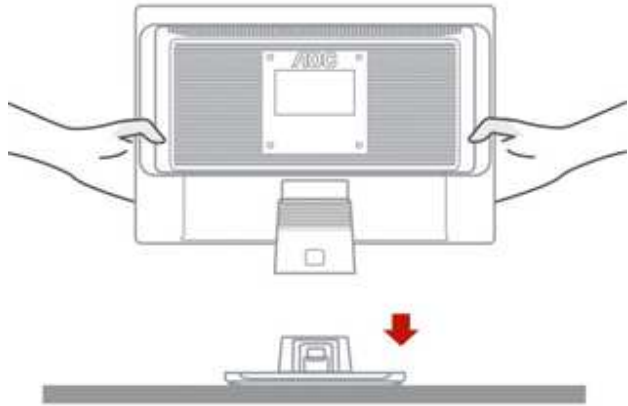

### Adjusting Viewing Angle

- For optimal viewing it is recommended to look at the full face of the monitor, then adjust the monitor's angle to your own preference.
- Hold the stand so you do not topple the monitor when you change the monitor's angle.
- You are able to adjust the monitor's angle from  $-5^{\circ}$  to  $20^{\circ}$ .

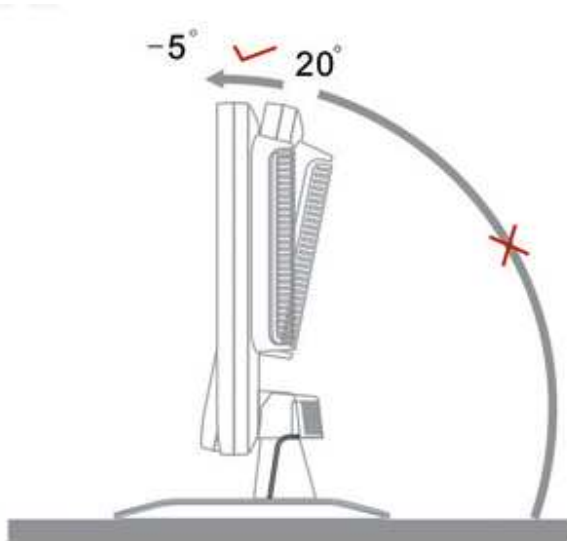



**NOTE:**

Do not touch the LCD screen when you change the angle. It may cause damage or break the LCD screen.

### Attaching the Cables

#### Cable Connections On Back of Monitor and Computer

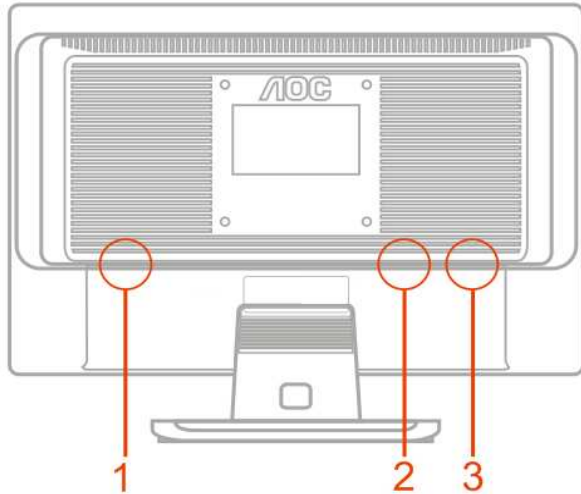

1. Power
2. DVI
3. Analog

Turn off your computer before performing the procedure below.

1. Connect the power cable to the AC port on the back of the monitor.
2. Connect one end of the 15-pin D-Sub cable to the back of the monitor and connect the other end to the computer's D-Sub port.
3. Turn on your monitor and computer.

If your monitor displays an image, installation is complete. If it does not display an image, see [Troubleshooting](#).

### Attaching Wall Mounting Arm

Preparing to Install An Optional Wall Mounting Arm

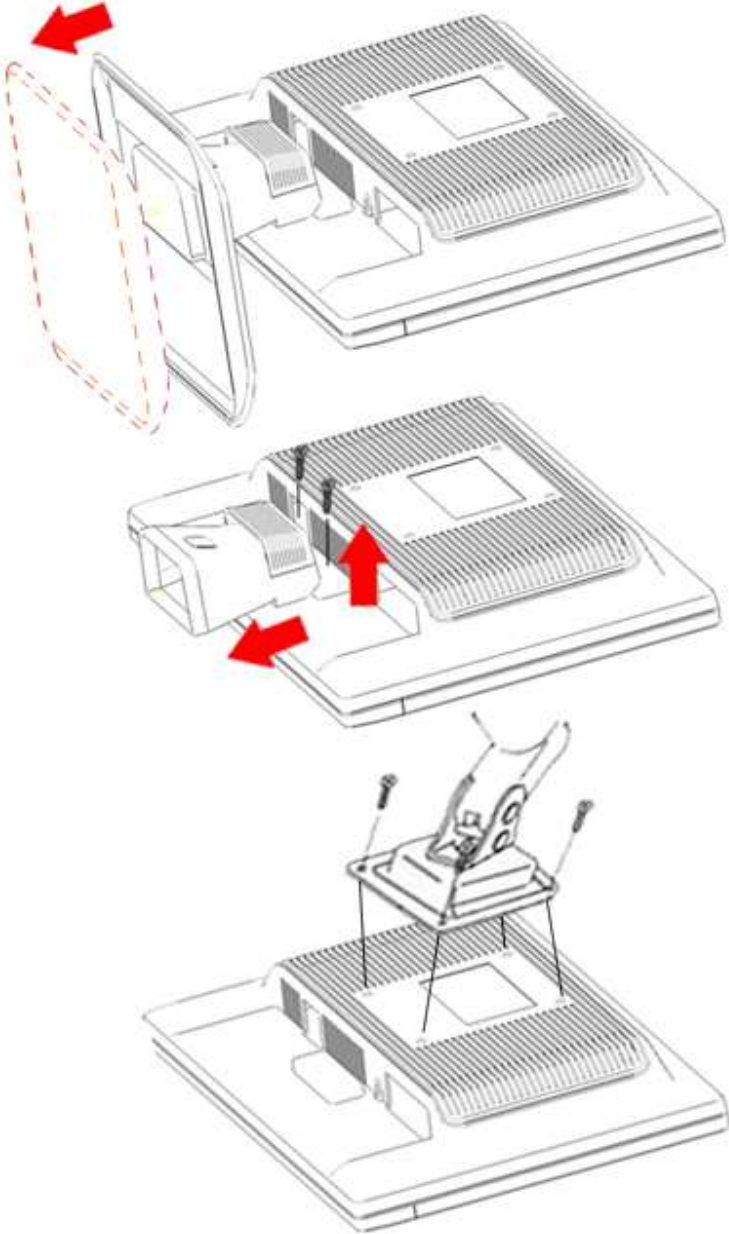

This monitor can be attached to a wall mounting arm you purchase separately. Disconnect power before this procedure. Follow these steps:

1. Remove the base.

2. Follow the manufacturer's instructions to assemble the wall mounting arm.
3. Place the wall mounting arm onto the back of the monitor. Line up the holes of the arm with the holes in the back of the monitor.
4. Insert the 4 screws into the holes and tighten.
5. Reconnect the cables. Refer to the user's manual that came with the optional wall mounting arm for instructions on attaching it to the wall.

Noted : VESA mounting screw holes are not available for all models, please check with the dealer or official department of AOC.

## 4. Using the Monitor

### Setting the Optimal Resolution

The recommended resolution for this monitor is 1680 by 1050. To setup the monitor to this resolution, follow the steps below.

1. Click **START**.
2. Click **SETTINGS**.
3. Click **CONTROL PANEL**.
4. Double click **DISPLAY**.
5. Click **SETTINGS**.
6. Set the resolution **SLIDE-BAR** to 1680 by 1050.

### External Controls

Press the power button to turn the monitor on or off. The other control knobs are located at front panel of the monitor (See Figure ). By changing these settings, the picture can be adjusted to your personal preferences.

\* The power cord should be connected.

\* Press the power button to turn on the monitor. The power indicator will light up.

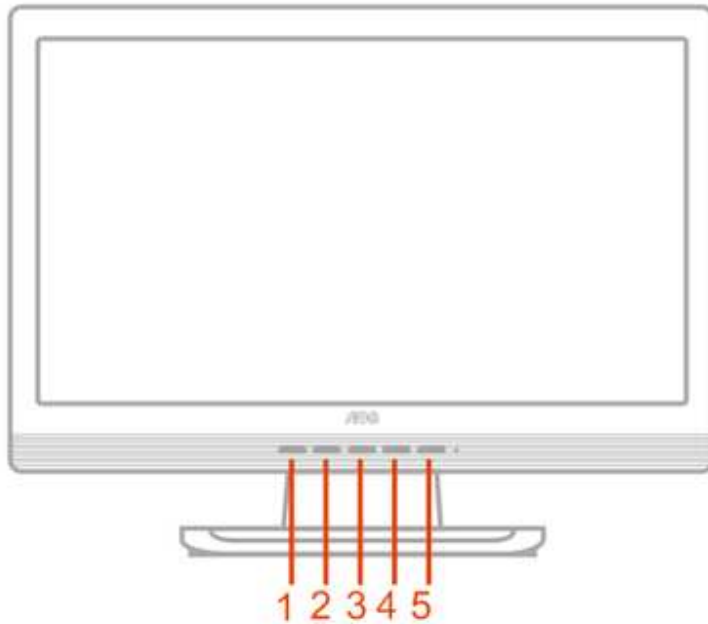

1. Auto Config
2. Eco Mode/ down
3. Up
4. Menu / Enter
5. Power Button & Indicator

### OSD Settings

- Press the MENU-button to activate the OSD window.
- Press+ or - to navigate through the functions. Once the desired function is highlighted, press the MENU-button to activate it. If the function selected has a sub-menu, press or again to navigate through the sub-menu functions. Once the desired function is highlighted, press MENU-button to activate it.
- Press+ or - to change the settings of the selected function. To exit and save, select the exit function. If you want to adjust any other function, repeat steps 2-3.
- OSD Lock Function: To lock the OSD, press and hold the MENUbutton while the monitor is off and then press power button to turn the monitor on. To un-lock the OSD - press and hold the MENUbutton while the monitor is off and then press power button to turn the monitor on.
- Eco Mode hot key : Press the Eco key continuously to select the Eco mode of brightness when there is no OSD ( Eco mode hot key may not be available in all models).
- Press Exit key continually for 7 sec. to turn on or off DDC-CI.

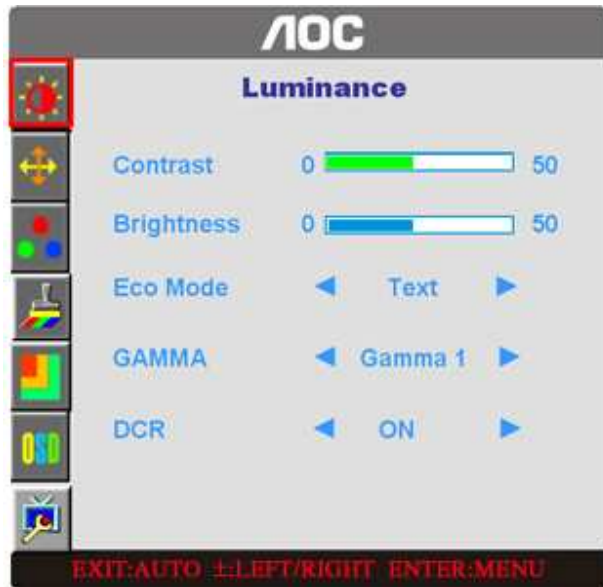

### DCB Adjustment



## Dynamic Color Boost

### What is DCB?

Dynamic Color Boost (DCB) is an advanced color adjustment technology. Through analyzing RGB signals, DCB creates more vivid and natural images to suit various color environment needs. DCB has two types of color enhancers: "Color Boost" and "Picture Boost" .



DCC: Dynamic color control  
 ICM: Intelligent color management

### 1) How to use Color Boost?

**YCM adjustment:** In addition to the basic R (red), G (green), B (blue) color adjustments, Color Boost has added Y (yellow), C (cyanine), and M (magenta) for more color fine-tuning options. YCM adjustments are in the third icon labeled "Color Temperature" in the OSD menu. When adjusting YCM values, RGB values will also be changed automatically due to the color correlation between RGB and YCM.

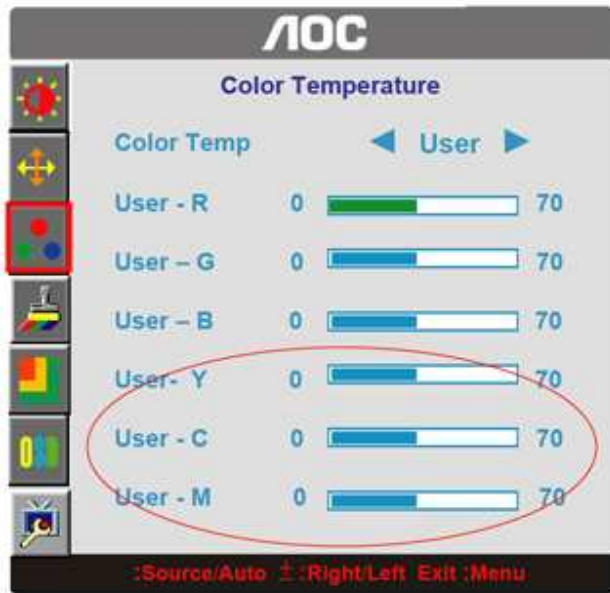

**Five color-enhancement settings:** To accommodate various display needs, Color Boost also offers 5 different color enhancement modes: Full Enhance, Natural Skin, Green Field, Sky Blue, and Auto-Detect. Please go to the fourth icon labeled "Color Boost" in the OSD menu and select one of the five settings you desire to be turned on.



**Full Enhance:** When "Full Enhance" is turned on, the color saturation of the entire screen is fully enriched, thus all colors become more vibrant.



**Nature Skin:** When "Natural Skin" is turned on, the red and yellow colors are enriched automatically, thus presents human skin with more natural and truer colors. "Natural Skin" setting is ideal for viewing human portrait and detailed skin texture.



**Green Field:** When "Green Field" is turned on, the green color is enriched so that football field and mountain landscape would look more natural and fresh. "Green Field" setting is ideal for watching mountain scenery and outdoor sports.



**Sky Blue:** When "Sky Blue" is turned on, the color blue is being fine-tuned so that the sky or ocean landscape will look more vivid and in-depth. "Sky Blue" setting is ideal for viewing sky and ocean images.



**Auto Detect:** When "Auto Detect" is turned on, every pigment will be detected and self-adjusted to render a lively picture.



**Demo:** Screen divided into two for demonstration purposes.

## 2) How to use Picture Boost?

Users can change the color settings of a self-selected zone on the screen. The size and position of the selected zone can also be adjusted. "Picture Boost" is located in the fifth icon labeled "Picture Boost" in the OSD menu. Turn on "Bright Frame" to select a zone on the screen to be enhanced. Please note when adjust or turn on any one of the DCB features, the rest of color settings including DCR will be disabled or return to default.

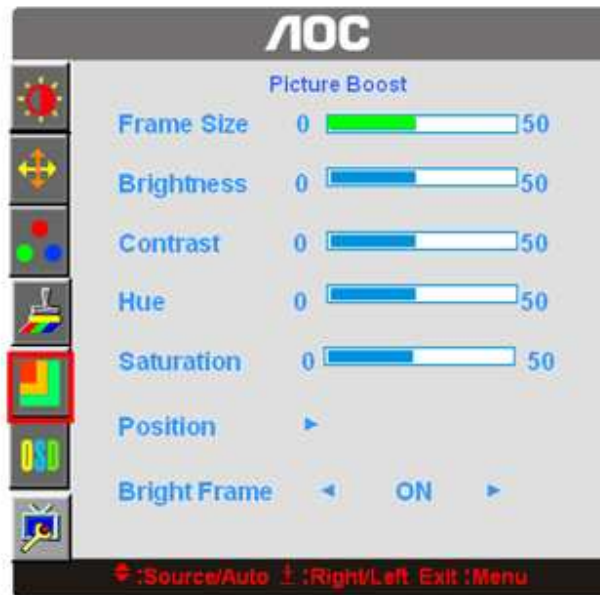

**Disclaimer:** DCB aftereffects are subject to the resolution and quality of the display content, hence may look different than the above illustrations.

**DCR Adjustment**



## Dynamic Contrast Ratio

### What is DCR?

Dynamic Contrast Ratio (DCR) auto adjusts the brightness of the screen so users can see the darker areas of the displayed content in more depths. By increasing the darkness of the dark areas and the brightness of the bright areas, contrast ratio is uplifted to exceed 2000:1. DCR value varies subject to the original CR values of the LCD module. The higher the original CR, the higher DCR can be achieved. DCR is great for watching movie or video contents.

### How to Use DCR?

Go to the first OSD icon labeled "Luminance", turn on or off DCR as desires. DCR boosts the contrasts between lightness & darkness and enables the viewer to see more layers and details of the picture, especially in the darker areas. Please note when DCR is on, DCB will be disabled.



**DCR Demos:**



**Disclaimer:** DCR aftereffects are subject to the resolution and quality of the display content, hence may look different than the above illustrations.

**Function Control Illustration**

	<b>Luminance</b>	<b>Adjust Range</b>	<b>Description</b>	
	Brightness	0-100	Backlight Adjustment	
	Contrast	0-100	Contrast from Digital-register.	
	Eco mode	Standard		Standard Mode
		Text		Text Mode
		Internet		Internet Mode
		Game		Game Mode
		Movie		Movie Mode
	Gamma	Sports		Sports Mode
		Gamma1		Adjust to Gamma1
		Gamma2		Adjust to Gamma 2
DCR	Gamma3		Adjust to Gamma 3	
	Off		Disable dynamic contrast ratio	
On		Enable dynamic contrast ratio		
	<b>Image Setup</b>			
	Clock	0-100	Adjust picture Clock to reduce Vertical-Line noise.	
	Focus	0-100	Adjust Picture Phase to reduce Horizontal-Line noise	
	H.Position	0-100	Adjust the verticalposition of the picture.	
	V.Position	0-100	Adjust the horizontal position of the picture.	
	<b>Color Temp.</b>			
	Warm		Recall Warm Color Temperature from EEPROM.	
	Normal		Recall Normal Color Temperature from EEPROM.	
	Cool		Recall Cool Color Temperature from EEPROM.	
	sRGB		Recall SRGB Color Temperature from EEPROM.	
	User	User-B	Blue Gain from Digital-register	

		User-G	Green Gain Digital-register.
		User-R	Red Gain from Digital-register
		User-Y	Yellow Gain from Digital-register
		User-C	Cyan Gain from Digital-register
		User-M	Magenta Gain from Digital-register
	<b>Color Boost</b>		
	Full Enhance	on or off	Disable or Enable Full Enhance Mode
	Nature Skin	on or off	Disable or Enable Nature Skin Mode
	Green Field	on or off	Disable or Enable Green Field Mode
	Sky-blue	on or off	Disable or Enable Sky-blue Mode
	AutoDetect	on or off	Disable or Enable AutoDetect Mode
	Demo	on or off	Disable or Enable Demo
	<b>Picture Boost</b>		
	Frame Size	0-100	Adjust Frame Size
	Brightness	0-100	Adjust Frame Brightness
	Contrast	0-100	Adjust Frame Contrast
	Hue	0-100	Adjust Frame Hue
	Saturation	0-100	Adjust Frame Saturation
	Position	H. position	Adjust Frame horizontal Position
		V. position	Adjust Frame vertical Position
Bright Frame	on or off	Disable or Enable Bright Frame	
	<b>OSD Setup</b>		
	H.Position	0-100	Adjust the vertical position of OSD
	V.Position	0-100	Adjust the horizontal position of OSD
	Timeout	0-100	Adjust the OSD Timeout
	Language		Select the OSD language
	<b>Extra</b>		
	Input Select	Digital	Select Digital Sigal Source as Input
		Analog	Select Analog Sigal Source as Input
	Auto Config	yes or no	Auto adjust the picture to default
	Reset	yes or no	Reset the menu to default
	DDC-CI		Turn ON/OFF DDC-CI Support
	Information		Show the information of the main image and sub-image source

### LED Indicators

Status	LED Color
Full Power Mode	Green or Blue
Active-off Mode	Orange or red

## 5. Drivers

## Windows 2000

1. Start Windows® 2000
  2. Click on the 'Start' button, point to 'Settings', and then click on 'Control Panel'.
  3. Double click on the 'Display' Icon.
  4. Select the 'Settings' tab then click on 'Advanced...'
  5. Select 'Monitor'
    - If the 'Properties' button is inactive, it means your monitor is properly configured. Please stop installation.
    - If the 'Properties' button is active. Click on 'Properties' button. Please follow the steps given below.
  6. Click on 'Driver' and then click on 'Update Driver...' then click on the 'Next' button.
  7. Select 'Display a list of the known drivers for this device so that I can choose a specific driver', then click on 'Next' and then click on 'Have disk...'
  8. Click on the 'Browse...' button then select the appropriate drive F: ( CD-ROM Drive).
  9. Click on the 'Open' button, then click on the 'OK' button.
  10. Select your monitor model and click on the 'Next' button.
  11. Click on the 'Finish' button then the 'Close' button.
- If you can see the 'Digital Signature Not Found' window, click on the 'Yes' button.

## Windows ME

1. Start Windows® Me
2. Click on the 'Start' button, point to 'Settings', and then click on 'Control Panel'.
3. Double click on the 'Display' Icon.
4. Select the 'Settings' tab then click on 'Advanced...'
5. Select the 'Monitor' button, then click on 'Change...' button.
6. Select 'Specify the location of the driver(Advanced)' and click on the 'Next' button.
7. Select 'Display a list of all the drivers in a specific location, so you can choose the driver you want', then click on 'Next' and then click on 'Have Disk...'
8. Click on the 'Browse...' button, select the appropriate drive F: ( CD-ROM Drive) then click on the 'OK' button.
9. Click on the 'OK' button, select your monitor model and click on the 'Next' button.
10. Click on 'Finish' button then the 'Close' button.

## Windows XP

1. Start Windows® XP
2. Click on the 'Start' button and then click on 'Control Panel'.
3. Select and click on the category 'Printers and Other Hardware'
4. Click on the 'Display' Item.
5. Select the 'Settings' tab then click on the 'Advanced' button.

6. Select 'Monitor' tab

- If the 'Properties' button is inactive, it means your monitor is properly configured. Please stop installation.

- If the 'Properties' button is active, click on 'Properties' button.

Please follow the steps below.

7. Click on the 'Driver' tab and then click on 'Update Driver...' button.

8. Select the 'Install from a list or specific location [advanced]' radio button and then click on the 'Next' button.

9. Select the 'Don't Search. I will choose the driver to install' radio button. Then click on the 'Next' button.

10. Click on the 'Have disk...' button, then click on the 'Browse...' button and then select the appropriate drive F: (CD-ROM Drive).

11. Click on the 'Open' button, then click the 'OK' button.

12. Select your monitor model and click on the 'Next' button.

- If you can see the 'has not passed Windows® Logo testing to verify its compatibility with Windows® XP' message, please click on the 'Continue Anyway' button.

13. Click on the 'Finish' button then the 'Close' button.

14. Click on the 'OK' button and then the 'OK' button again to close the Display\_Properties dialog box.

### Windows Vista

1. Start Windows® Vista

2. Click the Start button; select and click on 'Control Panel'.

3. Select and click on 'Hardware and Sound'

4. Choose 'Device Manager' and Click on 'Update device drivers'.

5. Select 'Monitor' and then right click on 'Generic PnP Monitor'.

6. Click on 'Update Driver Software'.

7. Select 'Browse my computer for driver software'.

8. Click the 'Browse' button and choose the drive in which you've placed the disk. Example:(CD-ROM Drive:\\Lcd\\PC\\drivers\\).

9. Click the 'Next' button.

10. Wait few minutes for installing the driver, and then click 'Close' button.

## 6. Technical Support

### Frequently Asked Questions

Problem & Question	Possible Solutions
<b>Power LED Is Not ON</b>	<ul style="list-style-type: none"><li>• Make sure the power button is ON and the Power Cord is properly connected to a grounded power outlet and to the monitor.</li></ul>
<b>No Plug &amp; Play</b>	<ul style="list-style-type: none"><li>• In order for the Plug &amp; Play feature of the monitor to work, you need a Plug &amp; Play compatible computer &amp; video card. Check with your computer manufacturer. Also check the monitor's video cable and make sure none of the pins are bent.</li></ul>

	<ul style="list-style-type: none"> <li>Make sure the AOC Monitor Drivers are installed (AOC Monitor Drivers are available at : <a href="http://www.aoc.com">http://www.aoc.com</a>)</li> </ul>
<b>Picture Is Fuzzy &amp; Has Ghosting Shadowing Problem</b>	<ul style="list-style-type: none"> <li>Adjust the Contrast and Brightness Controls.</li> <li>Make sure you are not using an extension cable or switch box. We recommend plugging the monitor directly to the video card output connector on the back of your computer.</li> </ul>
<b>Picture Bounces, Flickers Or Wave Pattern Is Present In The Picture</b>	<ul style="list-style-type: none"> <li>Move electrical devices that may cause electrical interference as far away from the monitor as possible.</li> <li>Use the maximum refresh rate your monitor is capable of at the resolution your are using.</li> </ul>
<b>Monitor Is Stuck In Active Off-Mode"</b>	<ul style="list-style-type: none"> <li>The Computer Power Switch should be in the ON position.</li> <li>The Computer Video Card should be snugly seated in its slot.</li> <li>Make sure the monitor's video cable is properly connected to the computer.</li> <li>Inspect the monitor's video cable and make sure none of the pins are bent.</li> <li>Make sure your computer is operational by hitting the CAPS LOCK key on the keyboard while observing the CAPS LOCK LED. The LED should either turn ON or OFF after hitting the CAPS LOCK key.</li> </ul>
<b>Missing one of the primary colors (RED, GREEN, or BLUE)</b>	<ul style="list-style-type: none"> <li>Inspect the monitor's video cable and make sure that none of the pins are bent.</li> <li>Make sure the monitor's video cable is properly connected to the computer.</li> </ul>
<b>Screen image is not centered or sized properly</b>	<ul style="list-style-type: none"> <li>Adjust H-Position and V-Position or press hot-key (AUTO).</li> </ul>
<b>Picture has color defects (white does not look white)</b>	<ul style="list-style-type: none"> <li>Adjust RGB color or select color temperature</li> </ul>
<b>Horizontal or vertical disturbances on the screen</b>	<ul style="list-style-type: none"> <li>Use win 95/98 shut-down mode Adjust CLOCK and FOCUS or perform hot-key (AUTO-key )</li> </ul>

## 7. Product Information

### Specifications

LCD Panel	Model number	2216Vw
	Driving system	TFT Color LCD
	Viewable Image Size	548mm diagoanl
	Pixel pitch	0.277mm(H) x 0.277mm(V)
	Video	R, G, B Analog Interface & Digital Interface
	Separate Sync.	H/V TTL
	Display Color	16.7M Colors
	Dot Clock	165 MHz
Resolution	Horizontal scan range	30 kHz - 83 kHz
	Horizontal scan Size(Maximum)	464.94mm
	Vertical scan range	56 Hz - 75 Hz

	Vertical scan Size(Maximum)	290.58mm
	Optimal preset resolution	1680 x 1050 (60 Hz)
	Highest preset resolution	1680 x 1050 (60 Hz)
	Plug & Play	VESA DDC2B/CI
	Input Connector	D-Sub 15pin & DVI-D
	Input Video Signal	Analog: 0.7Vp-p(standard), 75 OHM, Positive & DVI-D Digital Interface (TMDS)
	Power Source	100~240VAC, 47~63Hz
	Power Consumption	Active < 49W Standby < 2W
Physical Characteristics	Connector Type	15-pin Mini D-Sub & DVI-D
	Signal Cable Type	Detachable
	Dimensions & Weight:	
	Height (with base)	505.8 mm
	Width	404.6 mm
	Depth	210 mm
	Weight (monitor only)	5 kg
	Weight (with packaging)	7 kg
Environmental	Temperature:	
	Operating	0° to 50°
	Non-Operating	-20° to 60°
	Humidity:	
	Operating	10% to 85% (non-condensing)
	Non-Operating	5% to 80% (non-condensing)
	Altitude:	
	Operating	0~ 3000m (0~ 10000 ft )
Non-Operating	0~ 5000m (0~ 15000 ft )	

EPA ENERGY STAR ®



ENERGY STAR® is a U.S. registered mark. As an ENERGY STAR® Partner, AOC International (Europe) GmbH has determined that this product meets the ENERGY STAR® guidelines for energy efficiency.

**Preset Display Modes**

STAND	RESOLUTION	HORIZONTAL	VERTICAL
		FREQUENCY(kHZ)	FREQUENCY(Hz)
VGA	640x480	31.469	60
	640x480	37.861	72
	640x480	37.5	75

SVGA	800x600	35.156	56
	800x600	37.879	60
	800x600	48.077	72
	800x600	46.875	75
XGA	1024x768	48.363	60
	1024x768	56.476	70
	1024x768	60.023	75
SXGA	1280x1024	63.981	60
	1280x1024	79.976	75
WXGA	1440x900	55.935	59.8
WSXGA	1680x1050	65.29	60

**Pin Assignments**

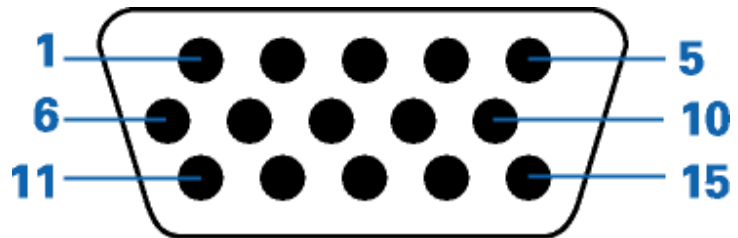

Pin Number	15-Pin Side of the Signal Cable
1	Video-Red
2	Video-Green
3	Video-Blue
4	N.C.
5	Ground
6	GND-R
7	GND-G
8	GND-B
9	+5V
10	Detect Cable
11	N.C.
12	DDC-Serial data
13	H-sync
14	V-sync
15	DDC-Serial clock

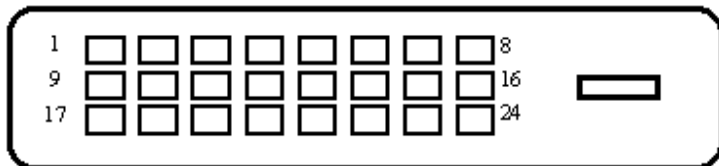

Pin No.	Signal Name	Pin No.	Signal Name	Pin No.	Signal Name
1	TMDS Data 2-	9	TMDS Data 1-	17	TMDS Data 0-
2	TMDS Data 2+	10	TMDS Data 1+	18	TMDS Data 0+
3	TMDS Data 2/4 Shield	11	TMDS Data 1/3 Shield	19	TMDS Data 0/5 Shield
4	TMDS Data 4-	12	TMDS Data 3-	20	TMDS Data 5-
5	TMDS Data 4+	13	TMDS Data 3+	21	TMDS Data 5+
6	DDC Clock	14	+5V Power	22	TMDS Clock Shield
7	DDC Data	15	Ground(for+5V)	23	TMDS Clock +
8	N.C.	16	Hot Plug Detect	24	TMDS Clock -

### Plug and Play

#### Plug & Play DDC2B Feature

This monitor is equipped with VESA DDC2B capabilities according to the VESA DDC STANDARD. It allows the monitor to inform the host system of its identity and, depending on the level of DDC used, communicate additional information about its display capabilities.

The DDC2B is a bi-directional data channel based on the I<sup>2</sup>C protocol. The host can request EDID information over the DDC2B channel.

## 8. Warranty Statement

### Warranty Statement

#### LIMITED THREE-YEAR WARRANTY\*

#### AOC Color Monitors sold within Europe

AOC International (Europe) GmbH warrants this product to be free from defects in material and workmanship for a period of Three (3) years after the original date of consumer purchase. During this period, AOC International (Europe) GmbH will, at its option, either repair the defective product with new or rebuilt parts, or replace it with a new or rebuilt product at no charge except as \*stated below. The defective products that are replaced become the property of AOC International (Europe) GmbH.

If the product appears to be defective, please contact your local dealer or refer to the warranty card when attached to the product.

Deliver the product freight pre-paid, along with the dated proof of purchase, to the AOC Authorized Service Center. If you cannot deliver the product in person:

- Pack it in its original shipping container (or equivalent)
- Put the RMA number on the address label
- Put the RMA number on the shipping carton
- Insure it (or assume the risk of loss/damage during shipment)
- Pay all shipping charges

AOC International (Europe) GmbH is responsible neither for any damage or loss during inbound transport damage nor to inbound product that was not properly packaged.

AOC International (Europe) GmbH will pay the return shipping charges within one of the countries specified within this warranty statement. AOC International (Europe) GmbH is not responsible for any costs associated with the transportation of product across international borders. This includes the international border within the European Union.

\* This limited warranty does not cover any losses or damages that occur as a result of

- Shipping or improper installation or maintenance
- Misuse
- Neglect
- Any cause other than ordinary commercial or industrial application
- Adjustment by non-authorized source
- Repair, modification, or installation of options or parts by anyone other than an AOC Authorized Service Center
- Improper environment
- Excessive or inadequate heating or air conditioning or electrical powers failures, surges, or other irregularities

This limited warranty does not cover any of the product firmware or hardware that you or any third party have modified or altered; you bear the sole responsibility and liability for any such modification or alteration.

ALL EXPRESS AND IMPLIED WARRANTIES FOR THIS PRODUCT (INCLUDING THE WARRANTIES OF MERCHANTABILITY AND FITNESS FOR A PARTICULAR PURPOSE) ARE LIMITED IN DURATION TO A PERIOD OF THREE (3) YEARS FOR PARTS AND LABOR FROM THE ORIGINAL DATE OF CONSUMER PURCHASE. NO WARRANTIES (EITHER EXPRESSED OR IMPLIED) APPLY AFTER THIS PERIOD.

AOC INTERNATIONAL (EUROPE) GMBH OBLIGATIONS AND YOUR REMEDIES HEREUNDER ARE SOLELY AND EXCLUSIVELY AS STATED HERE. AOC INTERNATIONAL (EUROPE) GMBH LIABILITY, WHETHER BASED ON CONTRACT, TORT, WARRANTY, STRICT LIABILITY, OR OTHER THEORY, SHALL NOT EXCEED THE PRICE OF THE INDIVIDUAL UNIT WHOSE DEFECT OR DAMAGE IS THE BASIS OF THE CLAIM. IN NO EVENT SHALL AOC INTERNATIONAL (EUROPE) GMBH BE LIABLE FOR ANY LOSS OF PROFITS, LOSS OF USE OR FACILITIES OR EQUIPMENT, OR OTHER INDIRECT, INCIDENTAL, OR CONSEQUENTIAL DAMAGE. SOME STATES DO NOT ALLOW THE EXCLUSION OR LIMITATION OF INCIDENTAL OR CONSEQUENTIAL DAMAGES, SO THE ABOVE LIMITATION MAY NOT APPLY TO YOU. ALTHOUGH THIS LIMITED WARRANTY GIVES YOU SPECIFIC LEGAL RIGHTS, YOU MAY HAVE OTHER RIGHTS, WHICH MAY VARY FROM COUNTRY TO COUNTRY. THIS LIMITED WARRANTY IS ONLY VALID FOR PRODUCTS PURCHASED IN THE MEMBER COUNTRIES OF THE EUROPEAN UNION.