

TABLE OF CONTENTS

FOR YOUR SAFETY	1
SAFETY PRECAUTIONS	2
SPECIAL NOTES ON LCD MONITORS	3
BEFORE YOU OPERATE THE MONITOR	3
FEATURES	3
PACKING LIST	3
CONTROLS AND CONNECTORS	5
ADJUSTING THE VIEWING ANGLE	6
OPERATING INSTRUCTIONS	7
GENERAL INSTRUCTIONS	7
HOW TO ADJUST A SETTING	9
ADJUSTING THE PICTURE	10-11
PLUG AND PLAY	12
TECHNICAL SUPPORT(FAQ)	13
ERROR MESSAGE & POSSIBLE SOLUTION	14
HOW TO INSTALL INF & ICM FILE	15
APPENDIX	16
SPECIFICATIONS	16-17
FACTORY PRESET TIMING TABLE	18
CONNECTOR PIN ASSIGNMENT	19

Before operating the monitor, please read this manual thoroughly. This manual should be retained for future reference.

FCC Class B Radio Frequency Interference Statement
WARNING: (FOR FCC CERTIFIED MODELS)

NOTE: This equipment has been tested and found to comply with the limits for a Class B digital device, pursuant to Part 15 of the FCC Rules. These limits are designed to provide reasonable protection against harmful interference in a residential installation. This equipment generates, uses and can radiate radio frequency energy, and if not installed and used in accordance with the instructions, may cause harmful interference to radio communications. However, there is no guarantee that interference will not occur in a particular installation. If this equipment does cause harmful interference to radio or television reception, which can be determined by turning the equipment off and on, the user is encouraged to try to correct the interference by one or more of the following measures:

1. Reorient or relocate the receiving antenna.
2. Increase the separation between the equipment and receiver.
3. Connect the equipment into an outlet on a circuit different from that to which the receiver is connected.
4. Consult the dealer or an experienced radio/TV technician for help.

NOTICE:

1. The changes or modifications not expressly approved by the party responsible for compliance could void the user's authority to operate the equipment.
2. Shielded interface cables and AC power cord, if any, must be used in order to comply with the emission limits.
3. The manufacturer is not responsible for any radio or TV interference caused by unauthorized modification to this equipment. It is the responsibilities of the user to correct such interference.

As an ENERGY STAR® Partner our company has determined that this product meets the ENERGY STAR® guidelines for energy efficiency.

WARNING:

To prevent fire or shock hazard, do not expose the monitor to rain or moisture. Dangerously high voltages are present inside the monitor. Do not open the cabinet. Refer servicing to qualified personnel only.

PRECAUTIONS

- Do not use the monitor near water, e.g. near a bathtub, washbowl, kitchen sink, laundry tub, swimming pool or in a wet basement.
- Do not place the monitor on an unstable cart, stand, or table. If the monitor falls, it can injure a person and cause serious damage to the appliance. Use only a cart or stand recommended by the manufacturer or sold with the monitor. If you mount the monitor on a wall or shelf, use a mounting kit approved by the manufacturer and follow the kit instructions.
- Slots and openings in the back and bottom of the cabinet are provided for ventilation. To ensure reliable operation of the monitor and to protect it from overheating, be sure these openings are not blocked or covered. Do not place the monitor on a bed, sofa, rug, or similar surface. Do not place the monitor near or over a radiator or heat register. Do not place the monitor in a bookcase or cabinet unless proper ventilation is provided.
- The monitor should be operated only from the type of power source indicated on the label. If you are not sure of the type of power supplied to your home, consult your dealer or local power company.
- The monitor is equipped with a three-pronged grounded plug, a plug with a third (grounding) pin. This plug will fit only into a grounded power outlet as a safety feature. If your outlet does not accommodate the three-wire plug, have an electrician install the correct outlet, or use an adapter to ground the appliance safely. Do not defeat the safety purpose of the grounded plug.
- Unplug the unit during a lightning storm or when it will not be used for long period of time. This will protect the monitor from damage due to power surges.
- Do not overload power strips and extension cords. Overloading can result in fire or electric shock.
- Never push any object into the slot on the monitor cabinet. It could short circuit parts causing a fire or electric shock. Never spill liquids on the monitor.
- Do not attempt to service the monitor by yourself; opening or removing covers can expose you to dangerous voltages and other hazards. Please refer all servicing to qualified service personnel.
- To ensure satisfactory operation, use the monitor only with UL listed computers which have appropriate configured receptacles marked between 100 - 240V AC, Min. 5A.
- The wall socket shall be installed near the equipment and shall be easily accessible.
- For use only with the attached power adapter (Output 12Vdc) which have **UL, CSA** listed license

SPECIAL NOTES ON LCD MONITORS

The following symptoms are normal with LCD monitor and do not indicate a problem.

NOTES

- Due to the nature of the fluorescent light, the screen may flicker during initial use. Turn off the Power Switch and then turn it on again to make sure the flicker disappears.
- You may find slightly uneven brightness on the screen depending on the desktop pattern you use.
- The LCD screen has effective pixels of 99.99% or more. It may include blemishes of 0.01% or less such as a missing pixel or a pixel lit all of the time.
- Due to the nature of the LCD screen, an afterimage of the previous screen may remain after switching the image, when the same image is displayed for hours. In this case, the screen is recovered slowly by changing the image or turning off the Power Switch for hours.
- When the screen becomes black or flashing, or cannot illuminate any more, contact your dealer or service center to replace parts. Don't repair the screen by yourself!

BEFORE YOU OPERATE THE MONITOR

FEATURES

- 43.2cm(17") TFT Color LCD Monitor
- Crisp, Clear Display for Windows
- *Recommended Resolutions: 1280 X 1024 @60Hz*
- EPA ENERGY STAR®
- Ergonomic Design
- Space Saving, Compact Case Design

CHECKING THE CONTENTS OF THE PACKAGE

The product package should include the following items:

1. LCD Monitor
2. Owner's Manual
3. Power Cord & Signal cable
4. External Adapter
5. Driver-Disk

POWERCORD:

1. Make sure that the power cord is the correct type required in your area.
2. This LCD monitor has an External universal power supply that allows operation in either 100/120V AC or 220/240V AC voltage area (No user adjustment is required.)
3. Connect the AC-power cord into your LCD monitor's External Adapter input socket, and then plug the other end of External adapter to LCD monitor's DC-power-input. The AC-power cord may be connected to either a wall power outlet or the power outlet socket on your PC, depending on the type of power cord supplied with your LCD monitor.

CONTROLS AND CONNECTORS

SIGNAL CABLE

Connecting the Signal Cable: the LCD monitor comes with a built-in signal cable. Plug the signal cable's 15-pin connector into the computer's VGA port and tighten the two screws on the cable connector.

Connecting the Power Cord: Plug the AC-power cord into the External Adapter. Then plug the DC-jack power cable into DC-IN Inlet.

Caution: If the AC outlet is not grounded (with three holes), install the proper grounding adapter (not supplied).

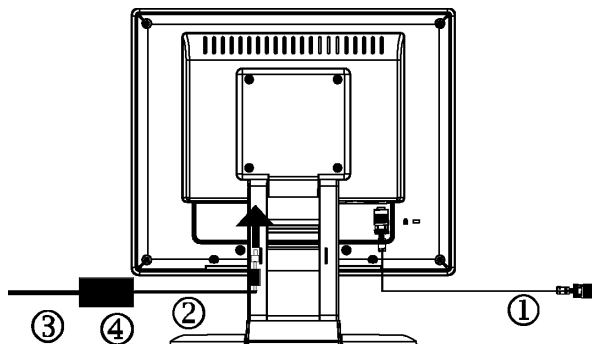

Figure 1 Connecting Cables

1.	Signal Cable	2.	DC-Jack Power Cable
3.	AC Power Cord	4.	External Adapter

ADJUSTING THE VIEWING ANGLE

- For optimal viewing it is recommended to look at the full face of the monitor, then adjust the monitor's angle to your own preference.
- Hold the stand so you do not topple the monitor when you change the monitor's angle.
- You are able to adjust the monitor's angle from -5° to 20° .

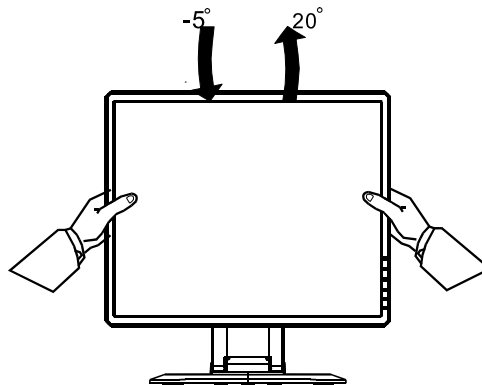

Figure 2

NOTES

- Do not touch the LCD screen when you change the angle. It may cause damage or break the LCD screen.
- Careful attention is required not to catch your fingers or hands when you change the angle.

OPERATING INSTRUCTIONS

GENERAL INSTRUCTIONS

Press the power button to turn the monitor on or off. The other control buttons are located at front panel of the monitor (See Figure 3). By changing these settings, the picture can be adjusted to your personal preferences.

- The power cord should be connected.
- Connect the video cable from the monitor to the video card.
- Press the power button to turn on the monitor position. The power indicator will light up.

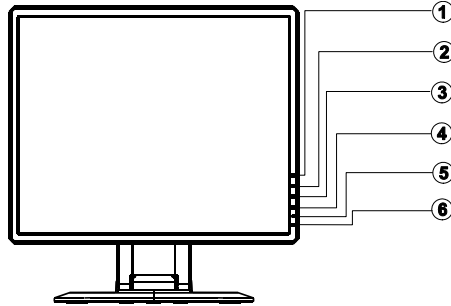





Figure 3 External Control Button

EXTERNAL CONTROLS

1.	Auto Adjust Key/Exit	2.	▲ / Brightness
3.	▼ / Contrast	4.	MENU/ENTER
5.	LED	6.	Power Key

FRONT PANEL CONTROL

- **Power Button:**
Press this button to switch ON/OFF of monitor's power.
- **MENU / ENTER :**
Active OSD menu or function adjust confirm or Exit OSD menu when in Brightness/Contrast OSD status.
- **Contrast  /  :**
Adjust contrast or function adjust.
- **Brightness  /  :**
Adjust brightness or function adjust.
- **Auto Adjust button / Exit:**
 1. When OSD menu is in active status, this button will act as EXIT-KEY (EXIT OSD menu).
 2. When OSD menu is in off status, press this button over 2 seconds to activate the Auto Adjustment function.
The Auto Adjustment function is used to set the HPos, VPos, Clock and Focus.
- **Power Indicator:**

Green	—	Power On mode.
Red	—	Off mode.

OSD Lock Function: To lock the OSD, press and hold the MENU button while the monitor is off and then press power button to turn the monitor on. To unlock the OSD - press and hold the MENU button while the monitor is off and then press power button to turn the monitor on.

NOTES

- Do not install the monitor in a location near heat sources such as radiators or air ducts, or in a place subject to direct sunlight, or excessive dust or mechanical vibration or shock.
- Save the original shipping carton and packing materials, as they will come in handy if you ever have to ship your monitor.
- For maximum protection, repack your monitor as it was originally packed at the factory.
- To keep the monitor looking new, periodically clean it with a soft cloth. Stubborn stains may be removed with a cloth lightly dampened with a mild detergent solution. Never use strong solvents such as thinner, benzene, or abrasive cleaners, since these will damage the cabinet. As a safety precaution, always unplug the monitor before cleaning it.

HOW TO ADJUST A SETTING

1. Press the MENU-button to activate the OSD window (Figure 4).
2. Press ▲ or ▼ to navigate through the functions. Once the desired function is highlighted, press the MENU-button to activate it. If the function selected has a sub-menu, press ▲ or ▼ again to navigate through the sub-menu functions. Once the desired function is highlighted, press MENU-button to activate it.
3. Press ▲ or ▼ to change the settings of the selected function.
4. To exit and save, select the exit function. If you want to adjust any other function, repeat steps 2-3.

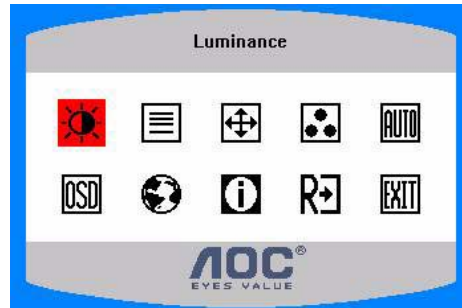





















Figure 4
The OSD Message

ADJUSTING THE PICTURE

The descriptions for function control LEDS

Main Menu Item	Main Menu Icon	Sub Menu Item	Sub Menu Icon	Description
Luminance		Contrast		Contrast from Digital-register.
		Brightness		Backlight Adjustment
Image Setup		Focus		Adjust Picture Phase to reduce Horizontal-Line noise
		Clock		Adjust picture Clock to reduce Vertical-Line noise.
Image Position		H. Position		Adjust the horizontal position of the picture.
		V. Position		Adjust the vertical position of the picture.
Color Temp.		Warm	N/A	Recall Warm Color Temperature from EEPROM.
		Cool	N/A	Recall Cool Color Temperature from EEPROM.
		sRGB	N/A	Recall sRGB from EEPROM.
		User / Red	R	Red Gain from Digital-register.
		User / Green	G	Green Gain Digital-register.
		User / Blue	B	Blue Gain from Digital-register.

Main Menu Item	Main Menu Icon	Sub Menu Item	Sub Menu Icon	Description
Auto Config		Yes	N/A	Auto Adjust the H/V Position, Focus and Clock of picture.
		No	N/A	Do not execute Auto Config, return to main menu.
OSD Setup		H. Position		Adjust the horizontal position of the OSD.
		V. Position		Adjust the vertical position of the OSD.
		OSD Timeout		Adjust the OSD timeout.
Language		Language	N/A	Set OSD language
Information		Information	N/A	Show the resolution, H/V frequency and input port of current input timing.
Reset		Yes	N/A	Clear each old status of Auto-configuration and set the color temperature to Cool.
		No	N/A	Do not execute reset, return to main menu.
Exit		N/A	N/A	Exit OSD

PLUG AND PLAY

Plug & Play DDC 2B Feature

This monitor is equipped with VESA DDC 2B capabilities according to the VESA DDC STANDARD. It allows the monitor to inform the host system of its identity and, depending on the level of DDC used, communicate additional information about its display capabilities.

The DDC 2B is a bidirectional data channel based on the I²C protocol. The host can request EDID information over the DDC 2B channel.

THIS MONITOR WILL APPEAR TO BE NON-FUNCTIONAL IF THERE IS NO VIDEO INPUT SIGNAL. IN ORDER FOR THIS MONITOR TO OPERATE PROPERLY, THERE MUST BE A VIDEO INPUT SIGNAL.

This monitor meets the Green monitor standards as set by the Video Electronics Standards Association (VESA) and/or the United States Environmental Protection Agency (EPA) and The Swedish Confederation Employees (NUTEK). This feature is designed to conserve electrical energy by reducing power consumption when there is no video-input signal present. When there is no video input signal this monitor, following a time-out period, will automatically switch to an OFF mode. This reduces the monitor's internal power supply consumption. After the video input signal is restored, full power is restored and the display is automatically redrawn. The appearance is similar to a "Screen Saver" feature except the display is completely off. The display is restored by pressing a key on the keyboard, or clicking the mouse.

TECHNICAL SUPPORT (FAQ)

Problem & Question	Possible Solution
Power LED is not on	*Check if the Power Switch is in the ON position *Power Cord should be connected
No Plug & Play	*Check if the PC system is Plug & Play compatible *Check if the Video Card is Plug & Play compatible *Check if the D-15 plug pin of Video Cable is bent *Make sure the LCD Monitor Drivers are installed
Picture is fuzzy	*Adjust the Contrast and Brightness Controls.
Picture bounces or a wave pattern is present in the picture	*Move electrical devices that may cause electrical interference.
The power LED is ON (orange) but there's no video or no picture.	*Computer Power Switch should be in the ON position. *Computer Video Card should be snugly seated in its slot. *Make sure monitor's video cable is properly connected to the computer. *Inspect monitor's video cable and make sure none of the pins are bent. *Make sure computer is operational by hitting the CAPS LOCK key on the keyboard while observing the CAPS LOCK LED. The LED should either turn ON or OFF after hitting the CAPS LOCK key.
Missing one of the primary colors (RED, GREEN, or BLUE)	*Inspect the monitor's video cable and make sure that none of the pins are bent.
Screen image is not centered or sized properly.	*Adjust pixel frequency (CLOCK) and FOCUS or press hot-key (AUTO).
Picture has color defects (white does not look white)	*Adjust RGB color or select color temperature.
Horizontal or vertical disturbances on the screen	*Use win 95/98 shut-down mode Adjust CLOCK and FOCUS or perform hot- key (AUTO-key).

CLOCK (pixel frequency) controls the number of pixels scanned by one horizontal sweep. If the frequency is not correct, the screen shows vertical stripes and the picture has not correct width.

FOCUS adjusts the phase of the pixel clock signal. With a wrong phase adjustment the picture has horizontal disturbances in light picture.

For FOCUS and CLOCK adjustment use "dot-pattern" or win 95/98 shut-down mode pattern.

ERROR MESSAGE & POSSIBLE SOLUTION

CABLE NOT CONNECTED :

1. Check that the signal-cable is properly connected , If the connector is loose, tighten the connector's screws.
2. Check the signal-cable's connection pins for damage.

INPUT NOT SUPPORT :

Your computer has been set to unsuitable display mode ,set the computer to display mode given in the following table.(see page 18)

HOW TO INSTALL THE DRIVER-DISK (INF & ICM FILE) FOR FIRST TIME INSTALL :

Your system may not recognize your flat-panel monitor, and as a result, you may need to complete the following steps for optimum performance of your monitor.

1. Check this LCD MONITOR is properly connected to your computer.
2. Restart the computer , when win95/98 detects the presence of a Plug and Play Monitor ,its device driver can be loaded and configured dynamically, insert LCD Monitor install disk to DISK A after the Win95/98 setup wizard is appeared. This setup wizard will lead you through the steps for configuring the system.
(Select " NEXT " for next steps and select driver A for LCD Monitor install file, if not select driver A ,the configuration system will automatically select the standard Plug and Play driver)
3. After the installation complete you can find the monitor complete name by following steps :
Click "**START**" , select "**SETTINGS**", select "**CONTROL PANEL**" "Select "**SYSTEM**", select "**DEVICE MANAGEMENT** ", select "**MONITOR**" icon and click twice ,you can see the description as follow : "**AOC LM727**"
if this description doesn't exist, or the "**MONITOR**" icon doesn't exist too, that means your installation is not successful.
Please delete the description with click the right button of mouse, and select The "remove or erase" to delete the description, if your step is successful, the "**MONITOR**" icon will disappear.
Please repeat this 2nd, 3rd steps if not success
4. After you complete above setup, please follow the steps below to operate your monitor at maximum performance :
 - A). Double click on the **My Computer** icon
 - B). Double click on the **Control Panel** icon
 - C). Double click on the **Display** icon, click on the **Settings** tab
 - D). In the **Desktop Area** drag the slider to resolution 1280x1024, and set the **Color palette** for 16-bit color
 - E). Click on the **Advanced Properties**
 - F). Select the **add-on card** tab , set the refresh rate to 60 Hz, click the **OK** button, and click on the **CLOSE** button

APPENDIX

SPECIFICATIONS

LCD Panel	Driving system	TFT Color LCD
	Size	43.2cm(17.0")
	Pixel pitch	0.264mm(H) × 0.264mm(V)
	Viewable angle	140° (H) 120° (V)
	Response time	12ms
Input	Video	R,G,B Analog Interface
	Separate Sync.	H/V TTL
	H-Frequency	30kHz – 80kHz
	V-Frequency	55-75Hz
Display Colors		16.2M Colors
Dot Clock		135MHz
Max. Resolution		1280 × 1024 @75Hz
Plug & Play		VESA DDC2B™
EPA ENERGY STAR®	ON Mode	<45W
	OFF Mode	≤2W
Input Connector		15-pin D-Sub
Input Video Signal		Analog:0.7Vp-p(standard), 75 OHM, Positive
Maximum Screen Size		Horizontal : 338mm Vertical : 270mm
Power Source		100~240VAC,47~63Hz
Environmental Considerations		Operating Temp: 5° to 35°C Storage Temp.: -20° to 60°C Operating Humidity: 10% to 85%
Dimension		367(W)×383.8(H)×245.9(D)mm
Weight (N. W.)		5.0kg Unit (net)

External Controls:	Switch	<ul style="list-style-type: none"> • Auto Adjust Key • ▲/ Brightness • ▼/ Contrast • Power Button • MENU
	Functions	<ul style="list-style-type: none"> • Contrast • Brightness • Focus • Clock • H. Position • V. Position • Auto Config • Language • Information • OSD Timeout • (Warm)Color • (Cool)Color • sRGB • User Color temperature • Reset • Exit
Power Consumption (Maximum)		45 Watts
Regulatory Compliance		UL, CSA, FCC, CE, TCO'99, ISO13406-2

Preset Display Modes

STANDARD	RESOLUTION	HORIZONTAL FREQUENCY	VERTICAL FREQUENCY
Dos-mode	720 × 400	31.47kHz	70Hz
VGA	640 × 480	31.47kHz	60Hz
	640 × 480	35.00kHz	66.6Hz
	640 × 480	37.50kHz	75Hz
	640 × 480	37.86kHz	72Hz
SVGA	800 × 600	37.879kHz	60Hz
	800 × 600	46.875kHz	75Hz
	800 × 600	35.16kHz	56Hz
	800 × 600	48.01kHz	72Hz
	832 × 624	49.725kHz	75Hz
XGA	1024 × 768	48.363kHz	60Hz
	1024 × 768	56.476kHz	70Hz
	1024 × 768	60.02kHz	75Hz
SXGA	1280 × 1024	64.00kHz	60Hz
	1280 × 1024	80.00kHz	75Hz

CONNECTOR PIN ASSIGNMENT

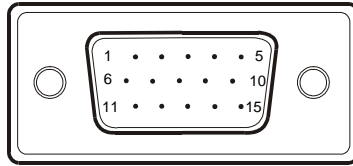

15 - Pin Color Display Signal Cable

PIN NO.	DESCRIPTION	PIN NO.	DESCRIPTION
1.	Red	9.	+5V
2.	Green	10.	VGA-CON.
3.	Blue	11.	Ground
4.	Ground	12.	DDC-Serial Data
5.	Ground	13.	H-Sync
6.	R-Ground	14.	V-Sync
7.	G-Ground	15.	DDC-Serial Clock
8.	B-Ground		